



DXP

*Dental
experience
gets
dynamic*



DXP is the NSK brand specialised in sterilization. The natural evolution of over 40 years of experience boasted by Dental X, DXP has inherited its solid technical and design expertise and brought a fresh, dynamic style to it. Its products are known and renowned worldwide for their reliability, efficiency and ability to tune into the needs of the new professionals in the dental and medical sector.

DXP was established with a clear vision: aspiring to build on the excellent results of safe and high-performance devices, such as the DXP Domina autoclave and the DXP NewSeal thermosealer, a community of professionals naturally inclined to seek and to appreciate the dimension of technology that is user-friendly, creative and aspires to customise their working environment.

Dental experience gets dynamic. So, why don't you?



DXP Domina	_04
DXP Purity	_07
DX17	_10
DXP NewSeal	_14
Accessories	_18

DXP DOMINA



RELIABLE AND AFFORDABLE

DXP Domina has been designed based on the essential functions, that a modern autoclave must be able to offer professionals and their team. This is clear from the moment you observe its elegant, compact design. Able to guarantee class B and class S sterilization cycles with impressive flexibility, it's only through time that all this autoclave's qualities really become evident, however. The most important of these is reliability, because DXP Domina is extremely robust, and the prime-quality materials and selected components reduce maintenance and therefore costs to a minimum.

DXP DOMINA

EFFECTIVE AND GENTLE

DXP Domina's task is clear and precise: to guarantee effective, gentle sterilization, allowing the operator to work comfortably and with no concerns. This result is achieved thanks to a number of technical solutions able to guarantee both quality and quantity: the spacious copper chamber ensures excellent load capacity, rapid and uniform heating, while the Adaptive Heat system eliminates temperature fluctuations, making it possible to sterilize even the most sensitive instruments, such as air turbines and handpieces, reducing the risk of damaging them to a minimum. And there's more: DXP Domina does all this with a noise level of just 53 db – and as we know, to work in comfort, silence is important too.



DXP DOMINA

ECO-FRIENDLY
SAFE

RELIABLE



AFFORDABLE

GENTLE

EFFECTIVE

SAFE AND ECO-FRIENDLY

One of the qualities that has made DXP Domina a benchmark for years in the sterilization sector, known and chosen by so many dentists worldwide, is its ability to combine performance with another fundamental, practical aspect: safety. Safety in the management of the autoclave, thanks to the bacteriological filter, the practical cap for filling the tank and the clean/dirty water tap, and safety in the post-sterilization cycle process, thanks to the integrated printer and optional Wi-Fi kit, which makes it possible to trace and file data quickly, easily and in full compliance with the regulations in force.

Another aspect that makes DXP Domina a convincing choice for the new generations of professionals is its ability to offer a practical, sustainable, eco-friendly solution, thanks to its impressive energy efficiency and the fact that it consumes just 530 ml of water to carry out a sterilization cycle.



DXP PURITY



Compliant with the EN 1717 standard, DXP Purity is a special fully automatic reverse osmosis system with three filters, to be placed on top of the autoclave to connect it to the mains water system and produce between 1,000 and 2,000 litres of high-quality demineralised water. Depending on the consumption of the autoclave, this makes it possible to carry out between 2,000 and 4,000 sterilization cycles effectively and reliably.

DXP DOMINA

STERILIZATION CYCLES

Cycle	Temperature	Sterilization	Drying	Vacuum	Type of Cycle	Maximum
B134	134° C	5'	10'	3	B	4 kg solid 1.5 kg porous
B121	121° C	20'	11'	3	B	4 kg solid 1.5 kg porous
S134	134° C	3'	5'	2	S	4 kg solid
CUSTOM	105-135° C	3'-9'	5'-12'	2-3-4		4 kg solid 1.5 kg porous
HELIX TEST	134° C	3'30"	10'	3	TEST	
B&D TEST	134° C	3'30"	10'	3	TEST	
VACUUM TEST	< 35° C			3	TEST	

TECHNICAL CHARACTERISTICS

	DXP DOMINA - 18 L
OVERALL DIMENSIONS	447 x 438 x 625 mm (L x H x D)
CHAMBER DIMENSIONS	Ø 240 - 384 mm (D)
CHAMBER VOLUME	17,5 L
WEIGHT (empty)	45 kg
POWER SUPPLY VOLTAGE	230 V 50/60 Hz
CONSUMPTION (power)	900 W - 1920 W
OPERATING TEMPERATURE	+10 - +40°C
OPERATING ALTITUDE (leaving the loading cap free)	up to 2000 m a.s.l.
OPERATING RANGE	Indoor use Relative humidity 85% Max. mains voltage variation ±10% Installation category II Pollution level 2
VOLUME OF WATER CONSUMED	0,6 litres
TANK CAPACITY (clean water and used water)	4 litres each
AUTOMATIC SWITCH-OFF	After 30' on standby at the end of the cycle

DXP PURITY

TECHNICAL CHARACTERISTICS

	DXP PURITY
OVERALL DIMENSIONS	450 x 140 x 510 mm (L x H x D) once installed
WEIGHT (empty)	10 kg
POWER SUPPLY VOLTAGE	230Vca 50-60Hz / 24Vca - 800mA
MAXIMUM CONSUMPTION	27VA
WATER SUPPLY	0,4-6 bar, min. 2 l/min
DRAINAGE	2 l/min

DXP DOMINA

SAFETY DEVICES

- Protection from electricity blackout
- Protection from short-circuit
- Protection from overheating
- Protection from overpressure
- Protection from accidental door opening
- Process evaluation system
- Real-time autodiagnosis system
- Adaptive Heat System
- Automatic switch-off system

CERTIFICATIONS

- Autoclave compliant with Directive 93/42/CEE as amended
- Class II B Device - Chamber compliant with Directive 2014/68/UE
- Company: ISO 9001- ISO 13485

MAIN COMPLIANCES WITH INTERNATIONAL STANDARDS

- EN 13060
- EN ISO 14971
- EN ISO 13485
- EN 61010-1
- EN 61010-2-040
- EN 61326-1
- EN 13445
- EN 62304

TECHNICAL DATA SHEET

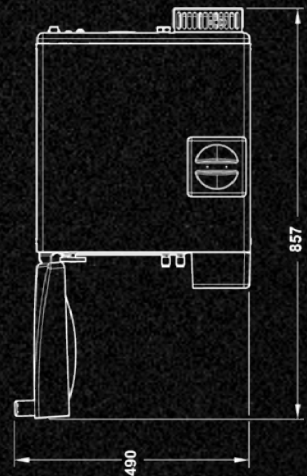
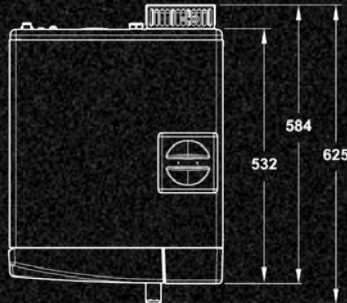
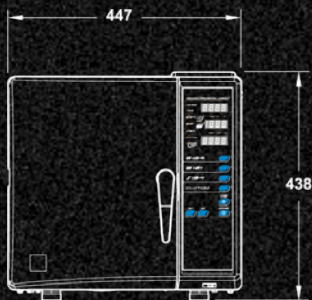

DXP PURITY

TECHNICAL DATA SHEET



DX 17

**DX
17**

EFFICIENT

A class S and N autoclave, equipped with 4 programs, DX 17 is fitted with a special pump to make instrument drying faster and more effective. At the end of the cycle, the machine switches off automatically, eliminating the risk of heating. Thanks to a Wi-Fi device, sterilization data can be recorded, guaranteeing cycle traceability simply and effectively.

COMPACT

DX17 weighs just 21 kg, with a simple, compact design. This means it can be placed conveniently in any setting, whether it has been chosen to equip a new sterilization workstation or to renew the devices already present in a dental practice.





EFFICIENT COMPACT SIMPLE



SIMPLE

Simply smart: this is the principle that inspired the design of every aspect of DX17. The practical side cuts at the base offer secure grip, making it even easier to move the device; the manual opening system and the clear, intuitive graphic interface make all operations easy, as well as safer than ever.

STERILIZATION CYCLES

Cycle	Temperature	Sterilization	Drying	Type of Cycle	Maximum load
134° SOLID	134° C	4'	2-12'	S-N	1-1,4 Kg
134° POROUS	134° C	14'	4-14'	S	0,2 Kg
121° SOLID	121° C	20'	2-12'	S-N	1-1,4 Kg
121° POROUS	121° C	30'	4-14'	S	0,2 Kg

TECHNICAL CHARACTERISTICS

	DX 17 - 6 L
OVERALL DIMENSIONS	377 x 303 x 435 mm (L x H x D)
CHAMBER DIMENSIONS	170 x 276 mm (ø x D)
CHAMBER VOLUME	6,0 L
WEIGHT (empty)	21 kg
POWER SUPPLY VOLTAGE	230 V 50/60 Hz
CONSUMPTION (power)	400 W - 700 W
OPERATING TEMPERATURE	+10 - +40°C
OPERATING ALTITUDE (leaving the loading cap free)	up to 2000 m a.s.l.
OPERATING RANGE	Indoor use Relative humidity 20 + 85% Temperature +10 - +40°C Atmospheric pressure 750 + 1050 mbar
VOLUME OF WATER CONSUMED	0,3 litres
TANK CAPACITY (clean water and used water)	2 litres
AUTOMATIC SWITCH-OFF	After 30' on standby at the end of the cycle

DX 17

SAFETY DEVICES

- Protection from electricity blackout
- Protection from short-circuit
- Protection from overheating
- Protection from overpressure
- Protection from accidental door opening
- Process evaluation system
- Real-time autodiagnosis system
- Adaptive Heat System
- Automatic switch-off system

CERTIFICATIONS

- Autoclave compliant with Directive 93/42/CEE as amended
- Chamber compliant with Directive 2014/68/UE
- Company: ISO 9001- ISO 13485

MAIN COMPLIANCES WITH INTERNATIONAL STANDARDS

- EN 13060
- EN ISO 14971
- EN ISO 13485
- EN 61010-1
- EN 61010-2-040
- EN 61326-1
- EN 13445
- EN 62304

TECHNICAL DATA SHEET

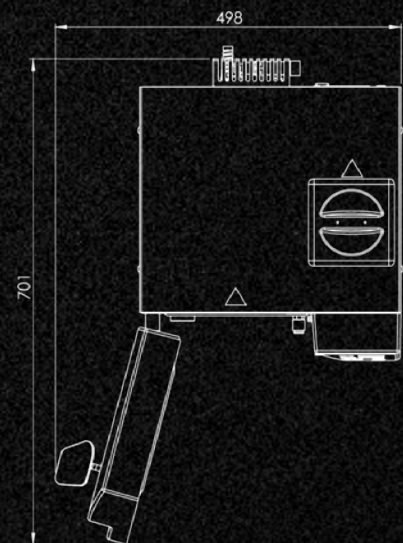
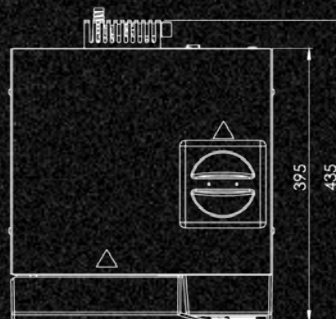
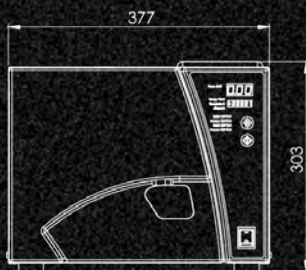

dxp NEWSEAL

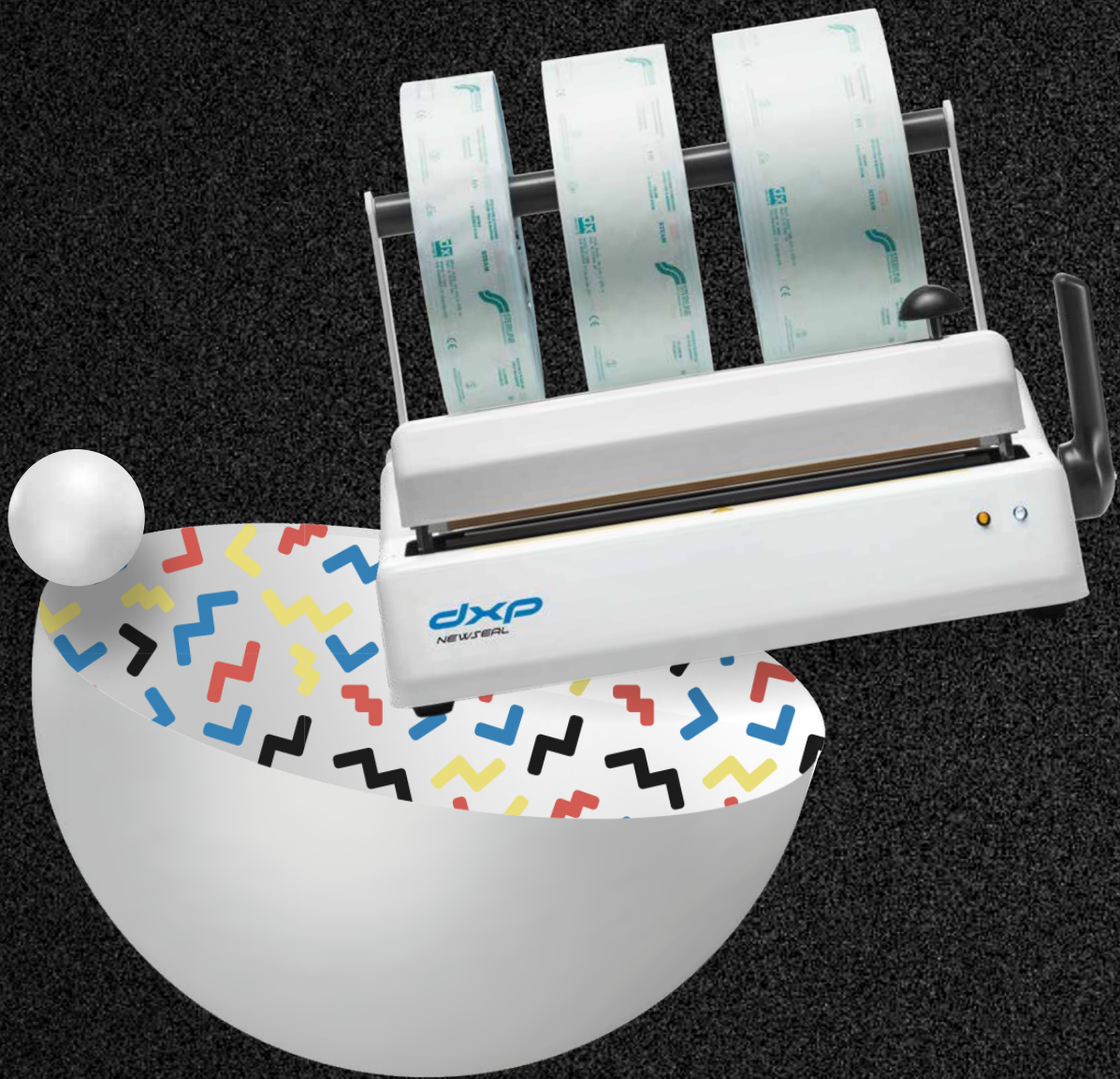

NEW SEAL

EFFECTIVE AND VERSATILE

Every professional - and their assistants responsible for reprocessing instruments and devices - knows that truly effective, safe sterilization starts even before the materials used during treatment are subjected to the cycle in the autoclave. It is essential that they are carefully sealed in disposable pouches, to avoid invalidating the process and compromising safety. The DXP NewSeal thermosealer allows this essential operation to be carried out not only effectively, but in a way that's practical and convenient for the operator.



DXP NEWSEAL

EFFECTIVE

RELIABLE



VERSATILE

SAFE

SAFE AND RELIABLE

DXP NewSeal is the perfect partner to complement the DXP Domina autoclave, because it impeccably seals the surgical instruments in pouches before insertion into the autoclave, so they remain sterile once the cycle is complete. Equipped with a self-adjusting heating element that produces a 10 to 11 mm seal, it starts sealing automatically when the lever is lowered. The built-in roll holder can house rolls of different sizes and in different combinations, and the anatomical anti-scald handle is safe and simple to use, even for less experienced operators.



TECHNICAL CHARACTERISTICS

	DXP NEWSEAL
DIMENSIONS (without rolls)	435 x 160 x 310 mm (L x H x D)
DIMENSIONS (with roll holder and rolls)	435 x 330/430 x 310 mm (L x H x D)
WEIGHT	7 kg
POWER SUPPLY	230 V 50/60 Hz
MAX. POWER	400 W
SEALING BAND	10 mm

TECHNICAL DATA SHEET

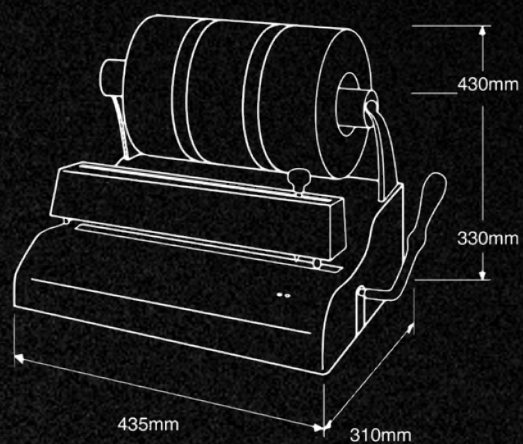
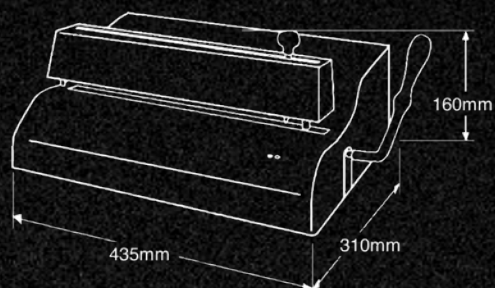

ACCESSORIES



EXTERNAL PRINTER

A convenient, compact, optional external printer for printing out cycle data when required.



WI-FI KIT

A device for storing sterilization cycle data on an external memory and sending them to any PC, tablet or smartphone, using a Wi-Fi connection. Includes: 1 Wi-Fi log and 1 connection cable.



HELIX TEST

Helix Test allows you to verify steam penetration into hollow instruments. The test consists of a plastic tubular device with an indicator recipient at the end, supplied with 250 control indicators. The indicators are easy to understand, and are compliant with the EN 867-5 standard.



REGENERATING TABS

Special effervescent tablets for cleaning the chamber of the autoclave. When placed inside the chamber before starting the dedicated cycle, it removes limescale and dirt residue from the boiler.



DX425

Demineralisation system for the treatment of water that makes it possible to turn regular mains water into water suitable for use in an autoclave.



